

FLOWBUS®



Valve **Control**
and **System**
Specialist



SIL
Applicable



ISO 9001:2008
ISO 14001:2004
OHSAS 18001:2007



CE 0036



Since its foundation in 2003, the company has experienced remarkable growth in the international valve automation industry. Our proactive approach, involving the flexibility needed to build tailor-made solutions along with continuous improvements and innovation, have allowed us to successfully and quickly develop our status in the global market. Our customers often remark on the excellent quality of Flowbus products and services.

Safety and Credibility

From feasibility studies, engineering, and design and manufacture to maintenance, the Flowbus Corporation is recognized as a leader in the valve automation market for providing enhanced value to our customers. Major business areas include the design and manufacture of industrial valve actuators, as well as the fabrication of valve control and safety systems that enable our customers to improve their performance while lowering their total installed and running costs.

Engineered Valve Control Expertise

Through the incorporation of engineering excellence and the latest precision manufacturing techniques, Flowbus offers comprehensive solutions for project-specific customer requirements. By combining our high quality product range, expertise, and process experience, we are able to solve complicated process problems with reliable, on-time packages.

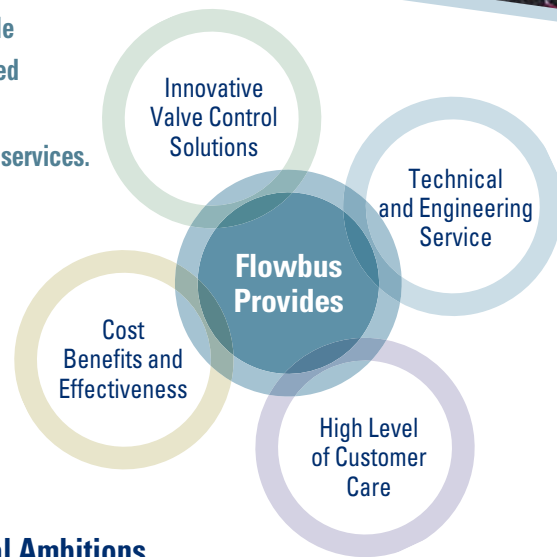

Global Ambitions

Flowbus has always been preparing to capitalize on the potential of the international market. Being a global corporation does not simply mean setting the goal of expanding our business abroad. It means accumulating knowledge and experience in local markets and with local clients. We can then move forward with a long-term relationship and partnership with clients from different countries to perfectly fulfill their requirements.

Applications



Oil & Gas

We combine our extensive knowledge of the actuator packages in the oil and gas extraction industry in relation to the operation and development of oil and gas fields as well as the petroleum refining industry to optimize plant processes. In particular, the EPT and EPA series actuators have been certified to meet SIL 3 and 4 ratings in accordance with IEC61508/61511, thus assisting our valuable customers in operating their plants safely.



Chemical

Flowbus meets the various requirements of the chemical industry such as those related to polyethylene, polypropylene, monomers, solvents, and ethylene oxide. Because these substances are flammable and reactive, special attention is required to control the environment during their production and handling. By providing a broad range of actuator packages, Flowbus ensures reliable solutions for the chemical and petrochemical industries.



Marine

An extensive knowledge of valves and actuators enables Flowbus to offer complete actuator units to the marine industry for FPSO, FSO, LNG, drilling rigs, TLPs, and other technologies, which will meet the challenges of various types of production floaters. A Flowbus actuator package provides the most advanced technology and operating production efficiency with high reliability and enhanced safety by bringing together specialized expertise in the offshore industry.



Power

Flowbus' reliable products and services support their client's requirements in energy applications. The EP & EH series actuators are designed to meet the harshest of service requirements and the most demanding of standards. Flowbus actuators are designed to exceed the customer's requirements in the most extreme environments on earth. Ultimately, this enables us to help you increase your operational effectiveness.



Desalination

Flowbus supplies complete valve automation systems for three main desalination technologies: multi-stage flash (MSF), multi-effect distillation (MED), and reverse osmosis (RO). Our proven project experience enables us to deliver reliable and cost-effective solutions with the shortest lead times in the industry and meet the market demand despite the fact that the world's consumption of fresh water is doubling every twenty years.

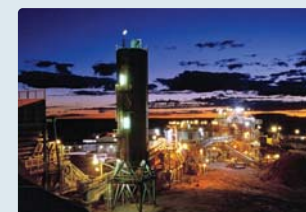

Mining

Flowbus' reliable actuators play critical roles in operating valves in severe mining applications, facing high pressure, slurry, and corrosive conditions. In processing facilities around the world, Flowbus is committed to providing essential expertise to the mining and mineral processing industry with technically and environmentally sustainable solutions. Based on our accurate data, extensive experience, and technical expertise, Flowbus improves the safety and efficiency of mining applications.

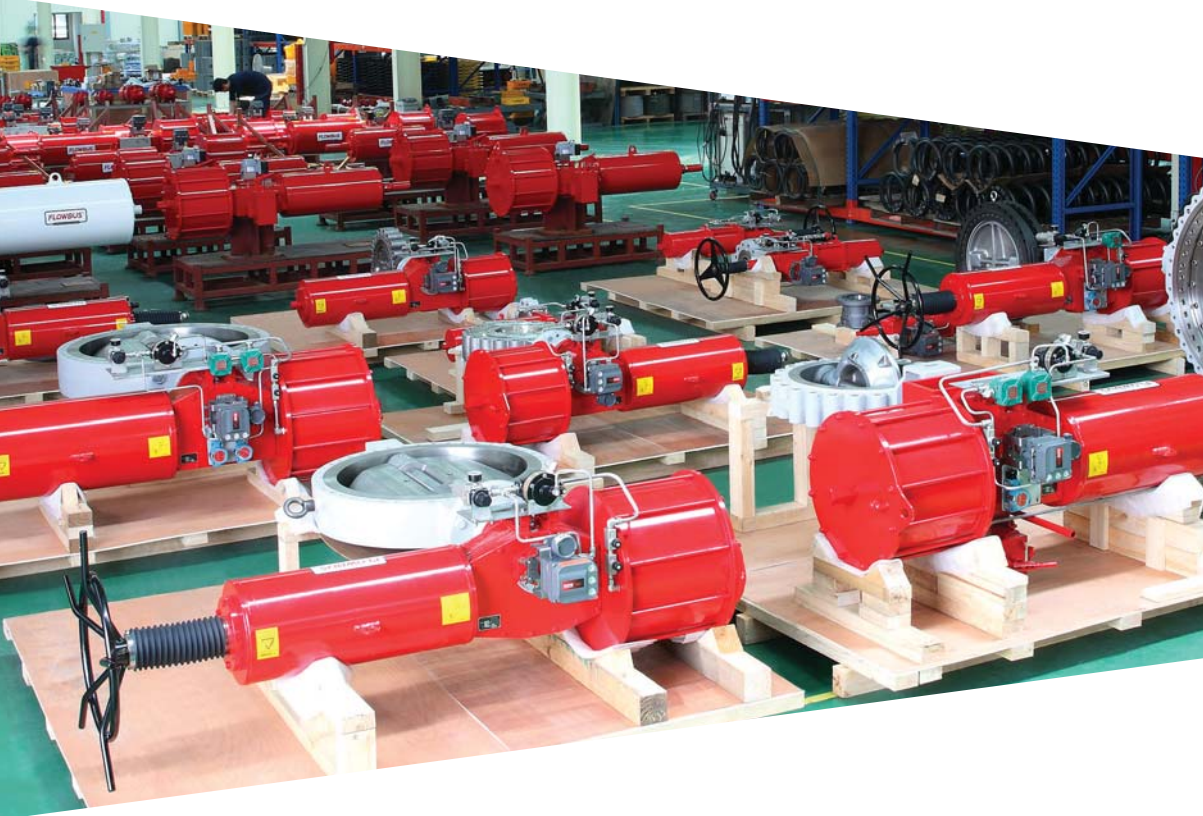

Testing, Accuracy, and Assurance



Flowbus is committed to providing our customers with quality products and comprehensive valve control solutions. Based on our extensive knowledge of the valve and actuator industry, we test and qualify a complete product through strict in-house tests. These tests are conducted on every single product before it leaves our premises. This allows us to ensure that they not only meet the required specifications but also exhibit superior performance that exceeds the customer's expectations.

Reliability through Proven Performance

Based on accurate data, extensive experience, excellent technical expertise, state of the art facilities, and strict in-house testing, Flowbus has been recognized as a reliable actuator manufacturer in the global valve market. The customized valve control solutions offered by Flowbus lead to considerably long, safe, and effective operation and maintenance in our customer's plants.

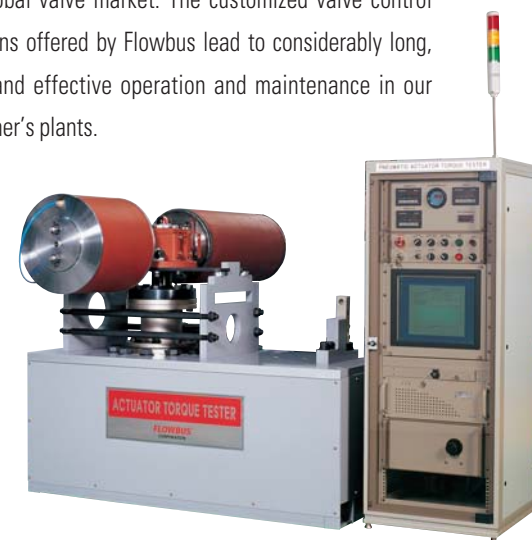

Continuous Research and Development

Flowbus focuses on the continuous improvement and innovation of our products and services through years of experience and study. Thanks to this commitment to developing high-quality and effective products, Flowbus is able to offer a wide range of pneumatic, hydraulic, and electro-hydraulic actuators with various designs: double acting, spring return, rack & pinion, symmetric, and canted yoke for rotary and linear valve operations. Quick valve actuation using pneumatic and hydraulic actuators designed by Flowbus ensure excellent valve control in less than 1 s to the valve's safe position.

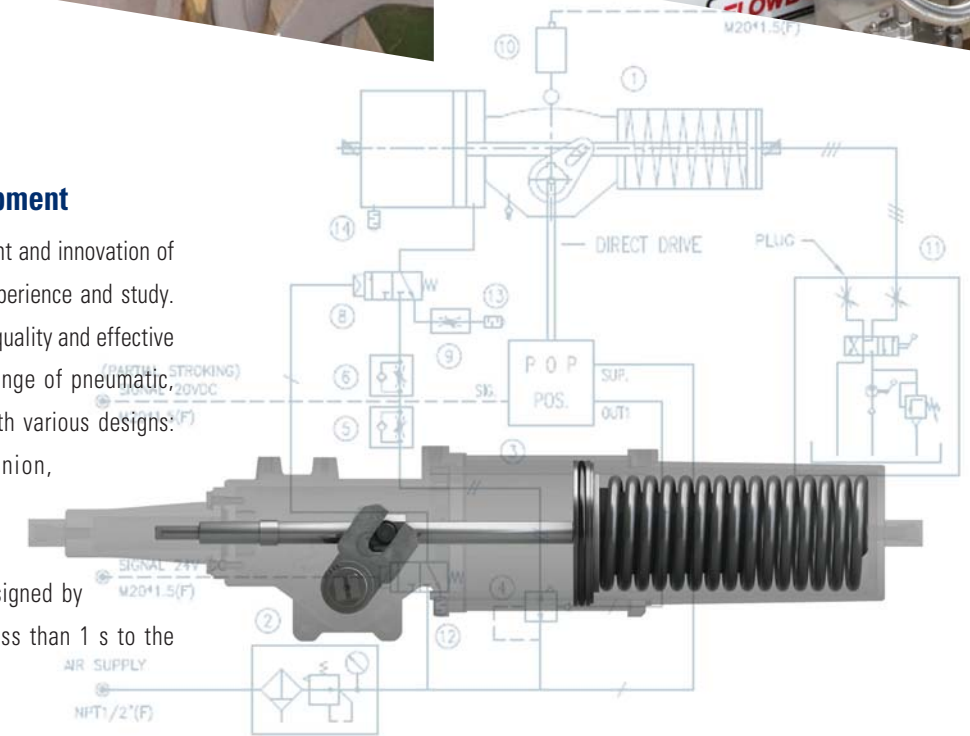

Standards and International Certification

Flowbus products are designed, manufactured, and inspected in conformity with

- ISO9001
- ISO14001
- SIL 3 & 4
- OHSAS 18001
- ATEX
- CE 0036
- GOST-R
- IP66/67



EP-Pneumatic Actuators, Quarter Turn

EPT Series : Heavy Duty Actuators



EPT-Series heavy-duty scotch yoke actuators are designed for rotary on-off or modulating duty, and can be provided with either symmetrical or canted torque output to suit the duty requirements of the valve. They have been certified to meet SIL 3, 4 ratings in accordance with IEC 61508/61511, which will support plant operations under safety instrumentation systems.

- Reliable Heavy Duty Design
- Torque range 398 N.m(3,682inch-lb) to 800,000 N.m (7,088,000 inch-lb)
- Symmetric and Canted Scotch Yoke Mechanism
- External Tie Rods for protection the cylinder tube
- Wear and Corrosion Resistance
- Advanced Sealing Compounds
- Suitable for severe applications

EPA Series : Heavy Duty Actuators

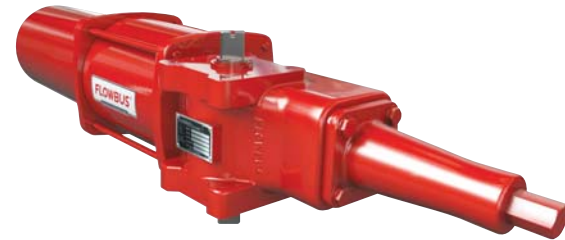

EPA-Series actuators provide rugged and compact solutions for quarter-turn valve actuation. The scotch yoke design offers a high torque output while reducing maintenance requirements. They have been designed with an inherently safe spring return unit that prevents the accidental release of the spring force, and ensures that installation or maintenance can be performed in complete safety.

- Inherently Safe Heavy Duty Design
- Torque range 36 N.m(310 inch-lb) to 6,957 N.m (61,570 inch-lb)
- Symmetric Scotch Yoke Mechanism
- Dual Valve Mounting Pads for easy change the spring fail mode
- Wear and Corrosion Resistance
- Advanced Sealing Compounds
- Suitable for harsh industries

EPR Series : Compact Actuators



EPR-Series actuators feature a compact Rack & Pinion and modern Scotch Yoke mechanisms. The extruded aluminum body incorporates an advanced, hard anodizing treatment on the internal and external surfaces and the body can also be provided in a number of optional finishes including PTFE coated, electroless nickel plated, and a variety of polyester power coated colors for durability increase and corrosion protection.

- Extremely compact and modern design
- Torque range 2 N.m (18 inch-lb) to 5,877 N.m (52,003 inch-lb)
- Rack and Pinion, Scotch Yoke Mechanism
- Extruded Aluminum Body
- Wide Range of Torque Outputs
- Corrosion Protection

EPAR Series : Compact Heavy Duty Actuators



An extremely compact rack & pinion EPAR actuators offer the most reliable and economical solutions under the harsh environments. The modular design allows the actuator to be easily converted from double acting to single acting configuration, and provide for the simple addition of ancillaries. The actuators are designed to provide safe, simple and compact performance and maintenance. The units are manufactured with the highest QA procedures, so confidence is built in.

- Extremely compact heavy duty actuators
- Torque range 12 N.m(52,016 inch-lb) to 4,200 N.m(37,173 inch-lb)
- Optimum for harsh environments
- Latest Design Technologies applied
- Advanced Rack and Pinion Mechanism
- Wear and Corrosion Resistance

EP-Pneumatic Actuators, Linear

EPL Series : Linear Actuators



Flowbus' EPL-Series linear actuators provide advantages of compact and high performance outputs in flow control systems. With a range of operating performance, Flowbus linear actuators offer reliability and long life, and have high technical performances. Our proven design and engineering expertise has developed a product suitable for the severe industry.

- Reliable and Compact Linear Actuators
- Thrust range 50 N(11 lbf) to 950,000 N(231,407 lbf)
- Suitable for harsh environments
- Double Acting and Spring Return
- Latest Design Technologies applied
- Corrosion Protection

Electro Hydraulic Actuators



The self-contained Electro-Hydraulic actuators consist of control, hydraulic, and power modules incorporating a motor driven pump with a hydraulic cylinder. These actuators offer complete tailor-made solutions to a client's application needs such as emergency shutdown (ESD), on-off modulating control, and partial stroking tests with minimal effect on the process.

- A Complete Tailor-made solution
- Versatility-Control, Hydraulic, Power Modules
- Various Power - Single phase, three phase or 24VDC
- Wear and Corrosion Resistance
- Bus Communications
- Suitable for severe applications

EH-Hydraulic Actuators, Quarter Turn

EHT Series : Heavy Duty Actuators

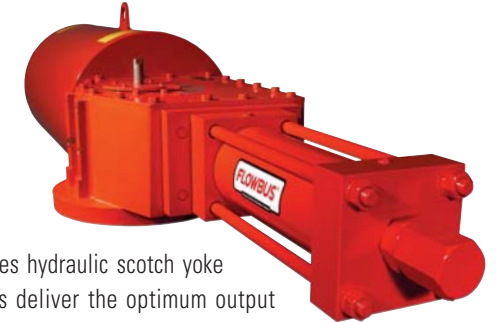

EHT-Series hydraulic scotch yoke actuators deliver the optimum output from the linear movement of the piston. This is ideal for quarter-turn valve applications. The EHT actuator is smaller than other actuators offering similar torque outputs, which reduces the overall valve package envelope, allowing for a more compact design.

- Reliable and Safe Heavy Duty Design
- Torque range 468 N.m(4,142inch-lb) up to 268,486 N.m (2,376,302inch-lb)
- Symmetric and Canted Scotch Yoke Mechanism
- Wear and Corrosion Resistance
- High levels of static and dynamic sealing
- Suitable for severe applications

EHA Series: Compact Heavy Duty Actuators



The rack & pinion EHA hydraulic actuators offer the most reliable and compact solutions under the harsh environments. Flowbus is able to make the EHA a high quality, reliable actuator, utilizing tried and tested methods of operation combined with the latest innovations in technology. A low friction, corrosion resistance internal coating is applied to ensure perfect operation of the internal components while the heavy duty construction and external coating protect the actuators from corrosive environments.

- Reliable and compact hydraulic actuators
- Torque range 12 N.m(52,016 inch-lb) to 4,200 N.m(37,173 inch-lb)
- Optimum for harsh environments
- Latest Design Technologies applied
- Advanced Rack and Pinion Mechanism
- Wear and Corrosion Resistance

Various Products & Services

Quick Operation Actuators

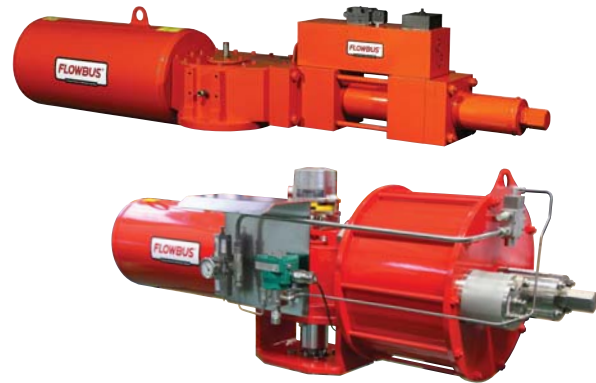

Flowbus can meet customer's requirement for achieving a very short time in emergency operation of valves with using our own technology such as damper valve and FQV service valve. We can provide two series of quarter turn quick operating actuators; Hydraulic and pneumatic quick acting actuator. Depending on customer requirements and process conditions, various ancillaries such as limit switches, solenoid valve, poppet solenoid valves and so on are optimally selected to ensure the perfect valve operation.

Fire Proofing Solutions

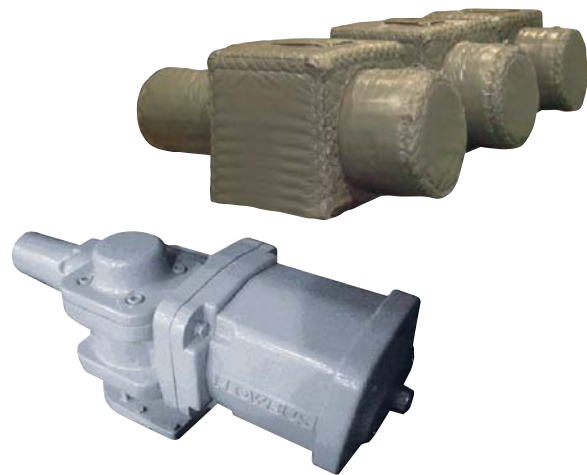

Through the installation of various fire protection systems, critical valve actuation systems can be efficiently protected from danger and damage from fire. Flowbus is able to offer fire proofing systems for both new and existing actuators and controls systems in accordance with UL 1709.

FB-Series : Declutchable Gear Override

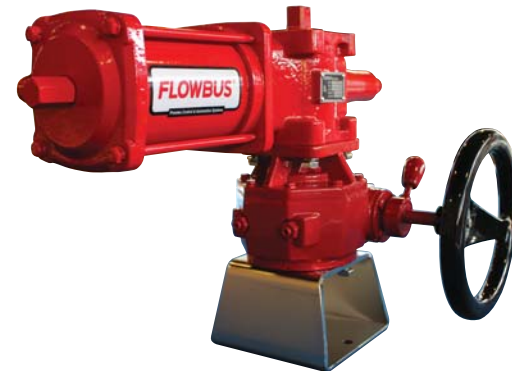

The compact FB declutchable gear override provides efficient, precise performance for quarter-turn manual override duties. The gearbox is specially designed to offer quick and simple operation of the highest torque valves when the air or power supply fails. High precision, self-locking gears provides safe, positive manual positioning and extend gearbox life.

- Efficient performance for manual operation duties
- Torque range 225 N.m to 9,700 N.m
- High precision, self-locking gear design
- Safe and Simple Operation
- Wear and Corrosion Resistance

Mounting Kits and Coupling



Flowbus mounting kits and couplings can be designed and manufactured for valves and actuators in accordance with ISO 5211 or to meet specific customer requirements.

Various Products & Services

Valve Automation Packages



Flowbus has been successfully building a good reputation in the valve automation industry by sharing our extensive knowledge of valves and actuators. We provide significant value added advantages to meet customer requirements and offer single source responsibility for all of

the valve automation systems that we design, build, test, and dispatch. Our experienced engineers take efficiency, reliability, and cost reduction seriously with the goal of suiting our customer's specifications, while they provide automation using

various ancillaries such as solenoid valves, position and limit switches, brackets, and other accessories. From simple on-off duties to complete modulating packages, Flowbus can supply the ideal automation package to suit almost any duty or customer requirement.

- Emergency Shutdown(ESD)
- High Integrity Pressure Protection Systems(HIPPS)
- Partial Stroke Test (PST) according to IEC61508
- Fire Protection to UL1709
- Pneumatic / Hydraulic Control Panels
- Local Control Panels
- Quick Operation
- Lockup Function
- Fieldbus Modulating Duties



Various Manual Overrides

Various manual overrides such as jackscrew, gear and hydraulic override can be incorporated in accordance with customer's requirements. The specially designed hydraulic override cylinder is installed inside the spring module; this standardizes actuator overall length and isolates the hydraulic fluid to eliminate contamination and spillage.

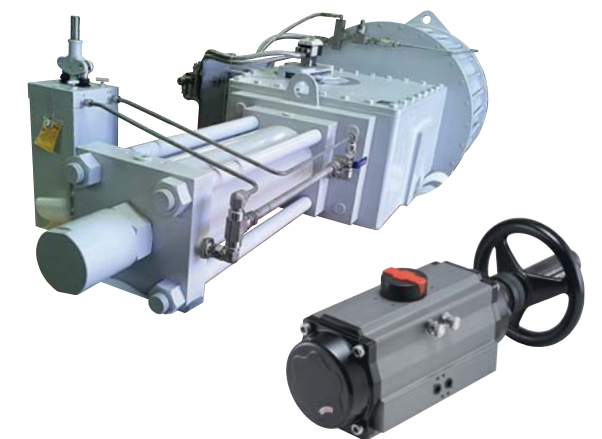

FLOWBUS[®] Corporation

Sales Office

7F, Insu Bldg, 205-4, Bangi-Dong, Songpa-Gu,
Seoul, 138-050, Korea
Tel : 82 2 400 1880 Fax : 82 2 400 8240
E-mail : sales@flowbus.com

Japan Office

Level 9, Edobori centre building, 2-1-1, Edobori,
Nishi-ku, Osaka, Japan 550-0003
Tel : 81 6 6225 1060
E-mail : japan@flowbus.com

Factory

703-1 Dadong, Sihwa Industrial Complex, 1239-8,
Jeongwang-Dong, Siheung-Si, Gyeonggi-Do, 429-450, Korea
Tel : 82 31 319 9301 Fax : 82 31 433 9180
E-mail : info@flowbus.com